

ExMP61R-1

ExMP61R-2

Explosion Proof
Rechargeable
LED Headtorch



Description

- Suitable for explosive environment class I, class II zone 0, 1, 2, class III zone 21, 22 and other professional portable lighting.
- Intrinsically safe explosion-proof design.
- The body is made of permanent anti-static, anti-aging and anti-corrosion high-strength alloy plastic injection molding, compact and lightweight, easy to carry.
- Professional optical lens design, soft illumination, uniform spot, in line with GB 30734 fire protection standard.

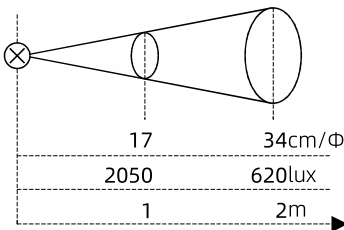

Parameters

Models:	ExMP61R-1	ExMP61R-2
Certifications:	IECEX, ATEX	IECEX, ATEX
Ex mark:	Ex ia I Ma Ex ia IIB T4 Ga IECEX Ex ib IIC T4 Gb Ex ib IIIB T130°C Db	Ex ia IIB T4 Ga IECEX Ex ib IIC T4 Gb Ex ib IIIB T130°C Db
	⚠ I M1 Ex ia I Ma ATEX ⚠ II 1 G Ex ia IIB T4 Ga ⚠ II 2 G Ex ib IIC T4 Gb ⚠ II 2 D Ex ib IIIB T130°C Db	⚠ II 1 G Ex ia IIB T4 Ga ATEX ⚠ II 2 G Ex ib IIC T4 Gb ⚠ II 2 D Ex ib IIIB T130°C Db
Usage:	I, II Zone 0/1/2, III Zone 21/22	II Zone 0/1/2, III Zone 21/22
Working ambient temp.:	-40°C ≤ T _a ≤ +55°C	-40°C ≤ T _a ≤ +55°C
Ingress protection:	IP66/67	IP66/67
CCT:	6500K	6500K
Luminous flux:	≥220lm (strong mode), ≥100lm (work mode), ≥100lm (SOS mode)	≥220lm (strong mode), ≥100lm (work mode), ≥100lm (SOS mode)
Run time:	≥8h (strong mode), ≥13h (work mode)	≥10h (strong mode), ≥18h (work mode)
Beam distance:	90m (strong mode), 55m (work mode)	90m (strong mode), 55m (work mode)
Battery type:	lithium battery (IEC 61233, IEC 61960)	lithium battery (IEC 61233, IEC 61960)
Battery capacity:	3.6V, 3350mAh	3.6V, 6700mAh
Charging way:	matched 1000/01-A61 charging base	matched 1000/01-A61 charging base
Charging time:	< 6.5h	< 14h
Recharging cycles:	500 cycles	500 cycles
Lifespan:	50,000h (without battery)	50,000h (without battery)

Note: The luminous flux and continuous discharge time are the values measured under the environment of -20°C ≤ T_a ≤ +55°C.

Features

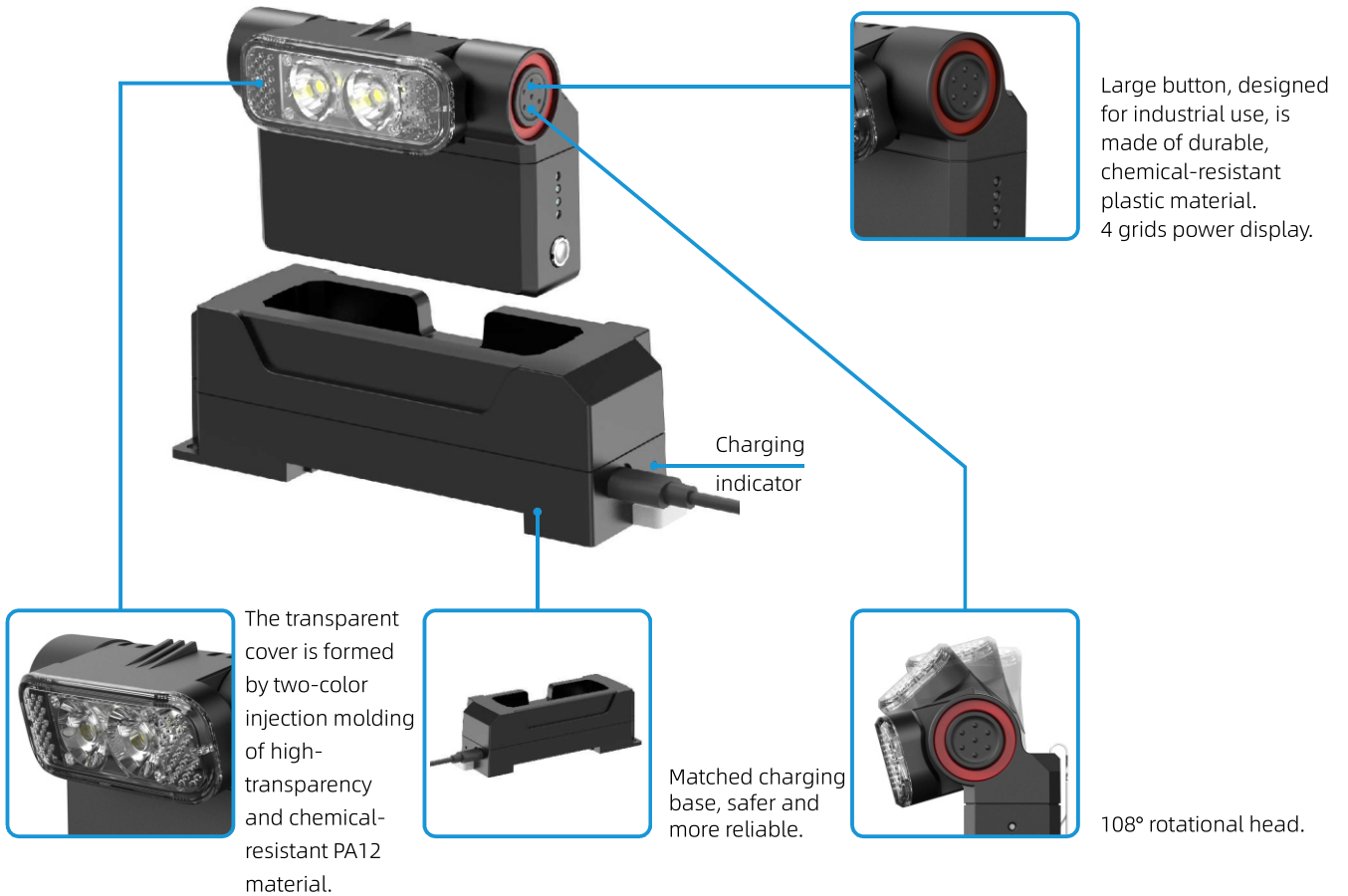

Order specifications

Illustration	Description	Battery capacity	Weight (g)	Order No.
	Explosion Proof Rechargeable LED Headtorch	3.6V, 3350mAh	159	ExMP61R-1
		3.6V, 6700mAh	209	ExMP61R-2
	Explosion Proof Rechargeable LED Headtorch + Charging base + Adapter	3.6V, 3350mAh	330	ExMP61R-1+A61-□-□
		3.6V, 6700mAh	380	ExMP61R-2+A61-□-□

GB
 EN
 BS
 ANSI
 AS
 JIS
 Code of plug

Installation accessories (see page 21 for details)
 Optional

Note: Users can choose type A integrated charging track rail and integrated charging stand. Please see pages 04 and 05 for details.

Installation diagram



Headband type



Helmet connecting type



Pocket clip type

Charging system

- ExMP61R-1 and ExMP61R-2 are equipped with a special charging base to ensure safe use. The charging base has a charging indicator light, red means charging, green means fully charged.
- The charging base has 2 charging ports - AC 100-250V/2A and a matched integrated charging port at the bottom. Safe, simple and convenient.
- This product is suitable for type A integrated charging track rail.

AC 100-250V,
50/60Hz

Individual Charging



Type A Integrated

Charging Track Rail



Integrated Charging Stand

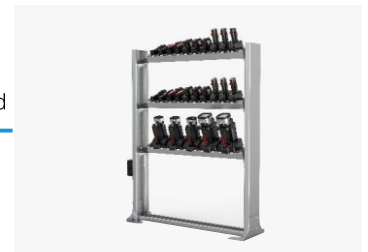





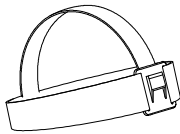
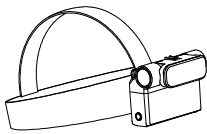
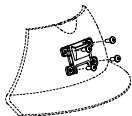
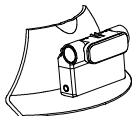

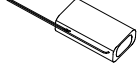

Note: For technical parameters of integrated charging track rail and integrated charging stand, please refer to pages 04 and 05.

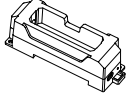
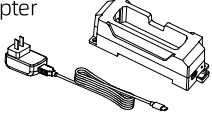
Spare parts

Illustration	Description	Weight (g)	Order No.
		61	1000/11-02-03
		4	1000/11-01-04

Spare parts

Illustration	Description	Weight (g)	Order No.
	3.6V, 6700mAh	100	1000/05-R61-2-Ex
	3.6V, 3350mAh	51	1000/05-R61-1-Ex
	Input voltage/ current: DC 5.0V/2000mA	102	1000/01-A61
	Input voltage/ current: AC 100-250V/500mA Input voltage/ current: DC 5.0V/2000mA	173	1000/01-A61-□

 GB
  EN
  BS
  ANSI
  AS
  JIS
 Code of plug

Outline dimension (unit: mm)

